

backward-curved, single-intake

with cube design

ebm-papst Mulfingen GmbH & Co. KG

Bachmühle 2 · D-74673 Mulfingen

Phone +49 7938 81-0

Fax +49 7938 81-110

info1@de.ebmpapst.com

www.ebmpapst.com

Limited partnership · Headquarters Mulfingen

Amtsgericht (court of registration) Stuttgart · HRA 590344

General partner Elektrobau Mulfingen GmbH · Headquarters Mulfingen

Amtsgericht (court of registration) Stuttgart · HRB 590142

Nominal data

Type	K3G900-AS08-01	
Motor	M3G200-QA	
Phase		3~
Nominal voltage	VAC	400
Nominal voltage range	VAC	380 .. 480
Frequency	Hz	50/60
Method of obtaining data		ml
Speed (rpm)	min ⁻¹	1050
Power consumption	W	8700
Current draw	A	13.5
Min. ambient temperature	°C	-25
Max. ambient temperature	°C	40

ml = Max. load · me = Max. efficiency · fa = Free air · cs = Customer specification · ce = Customer equipment
Subject to change

Data according to Commission Regulation (EU) 327/2011

		Actual	Req. 2015
01 Overall efficiency η_{es}	%	64.3	61.4
02 Measurement category		A	
03 Efficiency category		Static	
04 Efficiency grade N		64.9	62
05 Variable speed drive		Yes	

Data obtained at optimum efficiency level.

The ErP data is determined using a motor-impeller combination in a standardized measurement setup.

09 Power consumption P_{ed}	kW	8.68
09 Air flow q_v	m ³ /h	21530
09 Pressure increase p_{fs}	Pa	899
10 Speed (rpm) n	min ⁻¹	1045
11 Specific ratio*		1.01

* Specific ratio = $1 + p_{fs} / 100\,000\text{ Pa}$

LU-146118



Technical description

Weight	220 kg
Size	900 mm
Motor size	200
Rotor surface	Painted black
Electronics housing material	Die-cast aluminum, painted black
Impeller material	Sheet aluminum
Inlet nozzle material	Sheet steel, galvanized and coated with light gray plastic (RAL 7035)
Support structure material	Sheet steel, galvanized and coated with light gray plastic (RAL 7035)
Number of blades	7
Direction of rotation	Clockwise, viewed toward rotor
Degree of protection	IP54
Insulation class	"F"
Moisture (F) / Environmental (H) protection class	H1
Ambient temperature note	Occasional start-up between -40°C and -25°C is permissible. For continuous operation at temperatures below -25°C (e.g. refrigeration applications) we recommend our fan design with special low-temperature bearings.
Max. permitted ambient temp. for motor (transport/storage)	+80 °C
Min. permitted ambient temp. for motor (transport/storage)	-40 °C
Installation position	Shaft horizontal (base mounting only) or rotor on bottom; rotor on top on request
Condensation drainage holes	On rotor side
Mode	S1
Motor bearing	Ball bearing
Technical features	<ul style="list-style-type: none"> - Output 10 VDC, max. 10 mA - Output 20 VDC, max. 50 mA - Output for slave 0-10 V - Input for sensor 0-10 V or 4-20 mA - External 24 V input (parameter setting) - Alarm relay - Integrated PID controller - Power limiter - Motor current limitation - PFC, passive - RS-485 MODBUS-RTU - Soft start - Control input 0-10 VDC / PWM - Control interface with SELV potential safely disconnected from the mains - Temperature derating - Thermal overload protection for electronics/motor - Line undervoltage / phase failure detection
Touch current according to IEC 60990 (measuring circuit Fig. 4, TN system)	<= 3.5 mA
Electrical hookup	Terminal box
Motor protection	Reverse polarity and locked-rotor protection
Protection class	I (with customer connection of protective earth)
Conformity with standards	EN 61800-5-1; CE

K3G900-AS08-01

EC centrifugal module - RadiPac

backward-curved, single-intake

with cube design

Approval

CSA C22.2 No. 77 + CAN/CSA-E60730-1; EAC; UL 1004-7 + 60730



EC centrifugal module - RadiPac

backward-curved, single-intake
with cube design

Product drawing

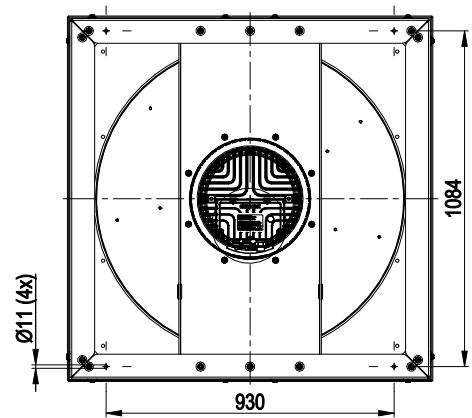
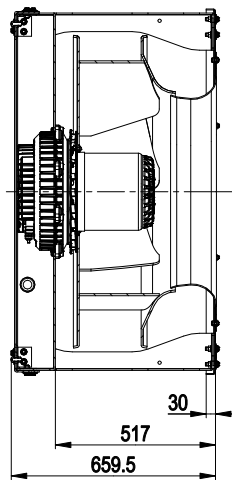
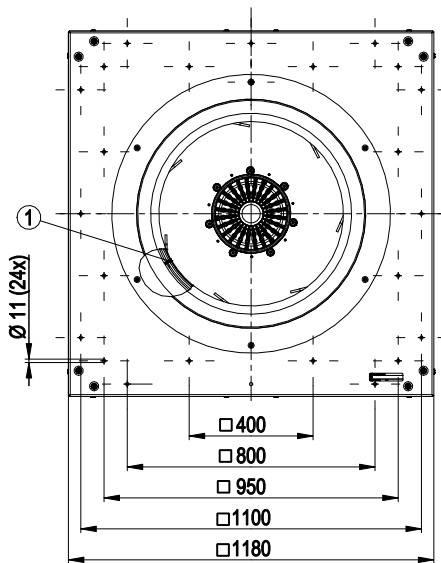
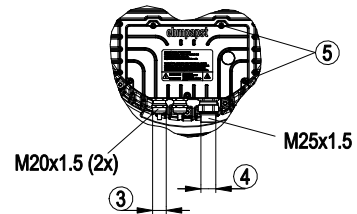
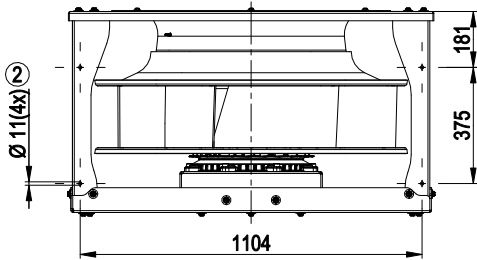

1	Inlet ring with pressure tap (k-factor: 900)
2	Mounting position for vibration-absorbing elements
3	Cable diameter min. 5 mm, max. 13 mm; tightening torque 6 ± 0.9 Nm
4	Cable diameter min. 16 mm, max. 20.5 mm, tightening torque 6 ± 0.9 Nm
5	Tightening torque 3.5 ± 0.5 Nm

Connection diagram

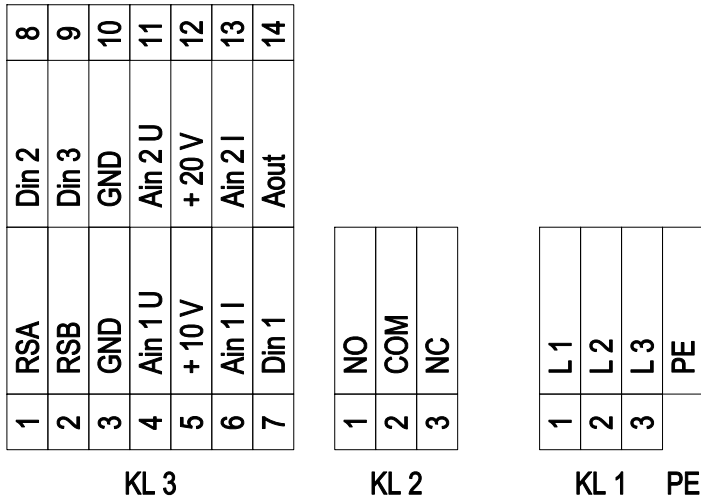

No.	Conn.	Designation	Function/assignment
KL 1	1	L1	Supply connection, power supply 3-phase 380-480 VAC, 50/60 Hz
KL 1	2	L2	Supply connection, power supply 3-phase 380-480 VAC, 50/60 Hz
KL 1	3	L3	Supply connection, power supply 3-phase 380-480 VAC, 50/60 Hz
PE		PE	Ground connection, PE connection
KL 2	1	NO	Status relay, floating status contact, make for failure
KL2	2	COM	Status relay, floating status contact; changeover contact; common connection; contact rating 250 VAC / max. 2 A (AC1) / min. 10 mA
KL2	3	NC	Status relay, floating status contact, break for failure
KL 3	1	RSA	Bus connection RS485, RSA, MODBUS RTU
KL 3	2	RSB	Bus connection RS485, RSB, MODBUS RTU
KL 3	3 / 10	GND	Reference ground for control interface
KL 3	4	Ain1 U	Analog input 1 (set value), 0-10 V, Ri = 100 kΩ, adjustable curves, only usable as alternative to input Ain1I
KL 3	5	+ 10 V	Fixed voltage output 10 VDC, +10 V ±3%; max. 10 mA; short-circuit-proof; power supply for external devices (e.g. pot)
KL 3	6	Ain1 I	Analog input 1 (set value), 4-20 mA, Ri = 100 Ω, adjustable curves, only usable as alternative to input Ain1U
KL 3	7	Din1	Digital input 1: enable electronics, enable: pin open or applied voltage 5...50 VDC; disable: bridge to GND or applied voltage < 1 VDC; reset function: triggers software reset after a level change to < 1 V
KL 3	8	Din2	Digital input 2: Switching parameter sets 1/2; according to EEPROM setting, the valid or used parameter set can be selected via bus or via digital input DIN2. Parameter set 1: pin open or applied voltage 5-50 VDC; parameter set 2: bridge to GND or applied voltage < 1 VDC
KL 3	9	Din3	Digital input 3: according to EEPROM setting, the integrated controller's direction of action can be selected as normal/inverse via bus or digital input; normal: pin open or applied voltage 5-50 VDC inverse: bridge to GND or applied voltage < 1 VDC
KL 3	11	Ain2 U	Analog input 2, measured value 0-10 V, Ri = 100 kΩ, adjustable curve, only usable as alternative to input Ain2I
KL 3	12	+ 20 V	Fixed voltage output 20 VDC, 20 V +25/-10%, max. 50 mA, short-circuit-proof power supply for external devices (e.g. sensors)
KL 3	13	Ain2 I	Analog input 2, measured value: 4-20 mA, Ri = 100 Ω, adjustable curve, only usable as alternative to input Ain2U
KL 3	14	Aout	Analog output 0-10 V, max. 5 mA, output of current motor modulation level / of the current motor speed. Adjustable curve.

Curves: Air performance 50 Hz

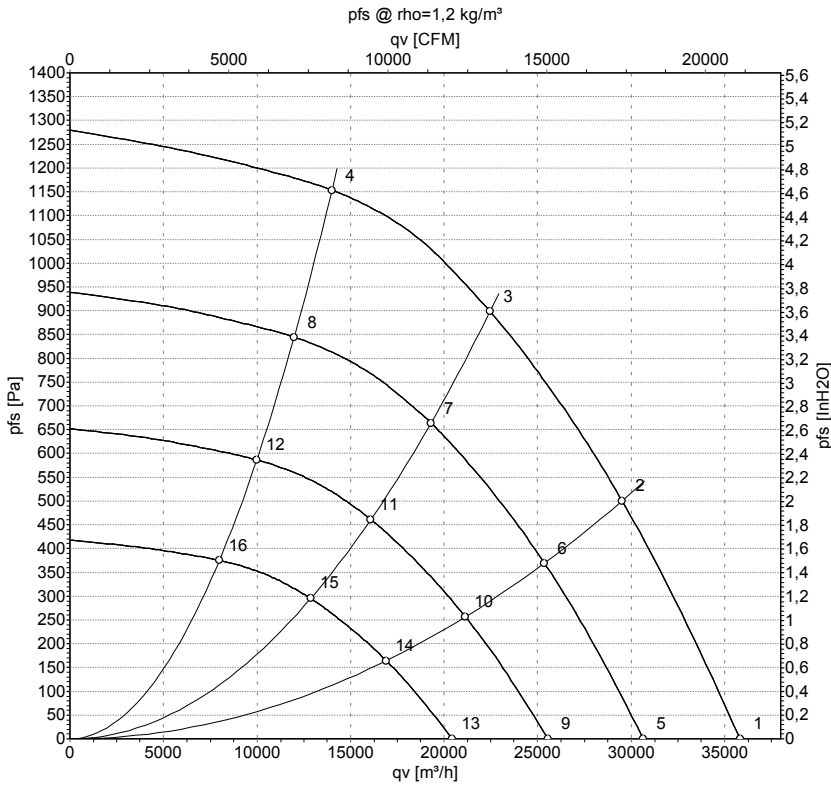

Measurement: LU-146118-1

Air performance measured according to ISO 5801 installation category A. For detailed information on the measurement setup, contact ebm-papst. Intake sound level: Sound power level according to ISO 13347 / sound pressure level measured at 1 m distance from fan axis. The values given are valid under the specified measuring conditions and may vary due to conditions of installation. For deviations from the standard configuration, the parameters have to be checked on the installed unit.

Measured values

	U	f	n	P _{ed}	I	LpA _{in}	LwA _{in}	LwA _{out}	q _v	P _{fs}	q _v	P _{fs}
	V	Hz	min ⁻¹	W	A	dB(A)	dB(A)	dB(A)	m ³ /h	Pa	cfm	in. wg
1	400	50	1050	5307	8.44	90	99	102	35820	0	21085	0.00
2	400	50	1050	7478	11.61	82	90	95	29520	500	17375	2.01
3	400	50	1050	8700	13.50	78	86	90	22450	900	13215	3.61
4	400	50	1050	8037	12.41	79	87	91	14005	1150	8245	4.62
5	400	50	900	3323	5.29	86	95	98	30645	0	18040	0.00
6	400	50	900	4746	7.37	78	87	91	25370	371	14930	1.49
7	400	50	900	5486	8.46	74	82	86	19300	664	11360	2.67
8	400	50	900	5034	7.77	75	83	87	11985	847	7055	3.40
9	400	50	750	1923	3.06	82	90	94	25540	0	15030	0.00
10	400	50	750	2747	4.26	73	82	86	21140	257	12445	1.03
11	400	50	750	3175	4.90	69	78	82	16080	461	9465	1.85
12	400	50	750	2913	4.50	70	79	83	9985	588	5880	2.36
13	400	50	600	985	1.57	76	84	88	20430	0	12025	0.00
14	400	50	600	1406	2.18	68	76	81	16915	165	9955	0.66
15	400	50	600	1626	2.51	64	72	76	12865	295	7570	1.18
16	400	50	600	1492	2.30	65	73	77	7990	376	4705	1.51

U = Voltage · f = Frequency · n = Speed (rpm) · P_{ed} = Power consumption · I = Current draw · LpA_{in} = Sound pressure level intake side · LwA_{in} = Sound power level intake side
 LwA_{out} = Sound power level outlet side · q_v = Air flow · P_{fs} = Pressure increase

