



ebmpapst

the engineer's choice

Best under pressure:
The pressure-resistant AxiEco series.

Victorious in the fight against ice formation, noise and energy losses.

About ebm-papst.

ebm-papst is a leader in ventilation and drive engineering technology and a much sought-after engineering partner in many industries. With around 20,000 different products, we have the perfect solution for practically every requirement. We believe the consistent further development of our highly-efficient GreenTech EC technology provides our customers with the best opportunities for the future in industrial digitization. With GreenIntelligence, ebm-papst already offers intelligent networked complete solutions that are unique anywhere in the world today.

ebmpapst

the engineer's choice

Six reasons that make us the ideal partner:

Our systems expertise: as experts in advanced motor technology, electronics and aerodynamics, we provide system solutions from a single source.

Our spirit of invention: our 600 engineers and technicians will develop a solution that precisely fits your needs.

Our lead in technology: with our EC technology and GreenIntelligence, we combine the highest energy efficiency with the advantages of IoT and digital networking.

Closeness to our customers: at 49 sales offices worldwide.

Our standard of quality: our quality management is uncompromising, at every step in every process.

Our sustainable approach: we assume responsibility with our energy-saving products, environmentally-friendly processes, and social commitment.

GreenIntelligence. *Making Engineers Happy.*



Why do our customers look so happy? Because when it comes to the Internet of Things and the digital transformation, we provide them with a clear competitive edge with GreenIntelligence for intelligent control and interconnection of fans, drives and systems to make applications more powerful, processes more efficient, businesses more successful and their customers more satisfied. From us you get the technologies that make all this possible, and the services that give you optimum support in all phases.

Our GreenIntelligence promise:

- Connection to higher-level communication points possible
- Control system tailored to the needs of the plant
- Constantly efficient cooling capacity

Liam uses intelligent technologies to optimize his applications and save time and money.



Top form under pressure: *the new AxiEco series.*

Tough ambient conditions prevail in the ventilation, air conditioning and refrigeration sector as well as in mechanical engineering. If you want to cope with them effectively, you need electrically and mechanically robust solutions that also work at a high level of efficiency. AC axial fans that have been widely used up until now will reach their limits in this contentious area by the time the next stage of the ErP comes into force. Or maybe not.

Because, with the strong AxiEco Protect and AxiEco Perform duo, ebm-papst has managed to develop a series that perfectly adapts to the requirements of evaporators, condensers, air heaters, heat pumps and switch cabinet and generator cooling systems, as well as numerous other applications.

Both axial fans in the AxiEco series impress with their robustness, high performance, low noise levels and economical operation in both the EC and AC versions.

Together they are: **BEST UNDER PRESSURE**. In other words, they always show what they are capable of when they are under high pressure. They are especially effective in combating high back pressures in ventilation, air conditioning and refrigeration applications: they are durable, highly efficient and quiet.

What exactly does that mean for individual sectors and applications? Take it from us:

Consistently resists ice formation:
the AxiEco series in refrigeration
technology.



The AxiEco series exhibits one of its great strengths in evaporator applications. If ice forms on the heat exchanger, the axial fan works with high efficiency for longer despite the increasing back pressure. The reason for this is its improved performance, which has a much steeper characteristic curve than usual, resulting in an extended evaporator service life, fewer defrosting cycles and a better overall system efficiency. The AxiEco series innovative design also helps the guard grill to freeze more slowly and the blades do not freeze on.

Conquering new power ranges:
the AxiEco series in ventilation and
air conditioning technology.



Thanks to aerodynamic improvements, the AxiEco Protect's air performance curve is steeper and the AxiEco Perform's air performance curve is even steeper than that of comparable axial fans. The series therefore covers a significantly larger power range and still works at optimum efficiency even when the back pressure is increasing. A great advantage for ventilation and air conditioning is that fewer fans are required to generate the same power. The reason for this is the power density: the AxiEco Perform in particular achieves a very high air performance per area. Despite its powerful performance, it is extremely quiet, which is apt in residential areas, for example.

Top performance in extremely confined
spaces: the AxiEco series in mechanical
engineering.



Thanks to a variety of design details, the AxiEco series is ideally adapted to various areas of application within mechanical engineering. In control cabinet construction, for example, the AxiEco Perform axial fan in particular boasts a significantly higher air performance, enabling manufacturers to reduce the total number of devices used. In all its sizes, the ErP-compliant AxiEco series impresses with its compact design, which can become a decisive competitive advantage considering the confined spaces seen in electronics and compressor cooling systems.

Conquering new power ranges: *the pressure-resistant AxiEco series.*

With the AxiEco Protect and the AxiEco Perform (pictured here in this photo), ebm-papst has developed a powerful series that impresses with significantly increased performance values. The series's air performance curve shows a steep upward trend. In terms of efficiency and pressure stability, no comparable axial fan comes close to it.

Good to know: the guard grill and inlet ring are already integrated into the AxiEco Perform in an easy-to-install plastic housing. This means that the fan is supplied as a complete plug & play solution including CE marking that can be used quickly, flexibly and easily in numerous applications.

Greater air throw thanks to efficient guide blades

The guide blades reduce the swirl in the outflow field of the fan and therefore reduce the dynamic share of losses to a minimum. This significantly increases the air throw compared to conventional axial fans.



Better throughflow thanks to easy-to-install composite housing

The AxiEco Perform housing is optimized according to aerodynamic criteria and has an integrated guard grill and cavities at the housing corners to improve the throughflow.



No freezing on the nozzle due to lack of tip gap

There is no tip gap between the fan housing and the impeller in the AxiEco series. The impeller, integrated diffuser ring and hub form a compact unit and the blade tips pass directly into the integrated diffuser ring. This has several advantages: there is no flow over the blade tips. Instead, it brings increased efficiency and improved noise characteristics. Therefore, the blades can no longer freeze on the fan housing.



1. Activate the module

Go into the ebm-papst Xplore app and select the AxiEco module.

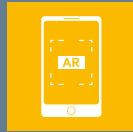

2. Scan the images

Aim the camera at the images marked with this icon, and away you go.

Increased efficiency thanks to pressure-boosting diffuser

In the AxiEco series, the diffuser ring is integrated directly into the impeller, where it acts as a diffuser. This means that the impeller has the largest out-flow angle possible. By increasing the pressure, the diffuser reduces outlet losses and increases the fan's efficiency. The diffuser also helps to reduce the noise.

Optimum throughflow thanks to impeller with improved geometry

The blade shape has undergone three-dimensional improvements and the impeller has been optimized based on the latest advancements in aerodynamics. The fan has an optimal throughflow thanks to the inlet ring that immerses in the impeller and thanks to the larger outlet opening.

Higher power density thanks to special blade design

The AxiEco series's fan blades have grooves on the rear. This increases its mechanical stability, in turn enabling a higher power density.



Questions and answers about *the AxiEco series.*



How do I determine whether AxiEco Protect or AxiEco Perform is best for my application?

The AxiEco Protect fan with guard grill and inlet ring is particularly well-suited to noise-sensitive applications, as its noise emissions are very low. By contrast, the AxiEco Perform fan with housing is recommended in situations that require a ready-to-install fan. With air flows over 12,000 m³/h and pressures of up to nearly 500 Pa, it is ideal for a broad spectrum of applications, ranging from heat pumps and evaporators to industrial ventilation systems and air compressor cooling. The AxiEco Perform can be used to intake or discharge air.

What makes the AxiEco series's outflow characteristics so special?

The AxiEco series is characterized by its improved flow profile, among other things. This is best shown when comparing it to the flow profile of a common axial fan:

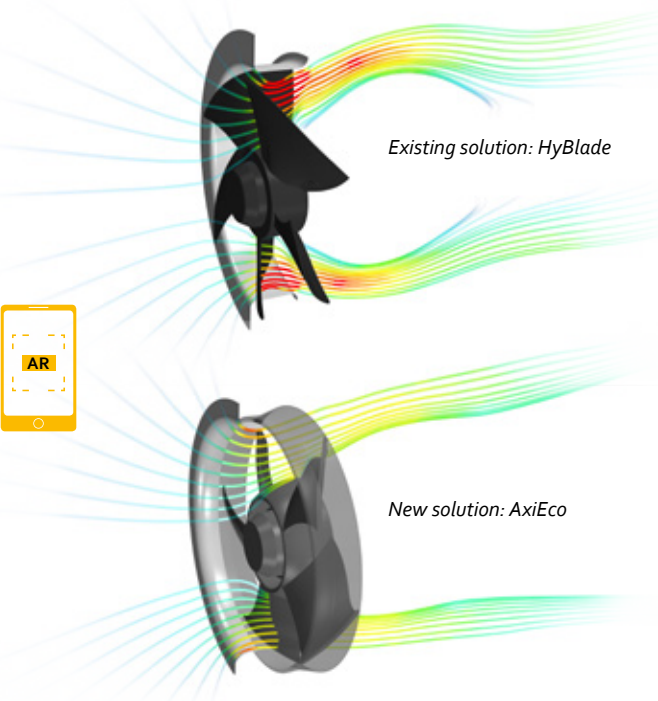

While the air flow of other axial fans spreads outwards, the outflow characteristic of the AxiEco series remains "on course" for longer, even when there are higher back pressures, and retains an axial direction. The flow direction remains constant and the air in the interior is therefore not taken in again.



How does the AxiEco series fight off ice formation?

Ice formation particularly afflicts evaporators if the humidity precipitates on the heat exchanger as ice at cold ambient temperatures. This means that the air path is restricted and the pressure increases. At higher back pressures, the AxiEco series offers significantly more pressure reserves than other fans. This extends the intervals between defrosting cycles and means that the refrigerating plant can be operated more efficiently for longer periods.

In addition, the impeller in the AxiEco series has no tip gap, meaning that the impeller is unlikely to freeze up. What's more, its impeller with integrated diffuser ring has been produced in highly resistant plastic, a material that discourages icing in and of itself.



Why is the AxiEco series's high power density advantageous?

Since the AxiEco series can be operated at higher speeds, it achieves a higher air performance per area. Compared to other axial fans, this means that fewer fans are required to deliver the same performance. This not only increases the overall efficiency, but also saves space.



How does the AxiEco series increase efficiency?

More stringent demands will be placed on the efficiency of fans by the time the next stage of the ErP comes into force. The AxiEco series already easily fulfills these criteria: the AxiEco Perform offers a significant increase in efficiency compared to the HyBlade with full nozzle.



Why is the AxiEco Protect so incredibly quiet?

The AxiEco series is up to 6 dB(A) quieter than the HyBlade (depending on the size). The main reason behind this is that the impeller, integrated diffuser ring and hub form a compact unit. The blade tips seamlessly join the integrated diffuser ring so there is no longer any tip gap between the fan housing and the impeller. This results in hardly any turbulence in the edge area – and therefore also less noise. The integrated diffuser also helps to reduce noise, meaning that the noise level remains pleasantly low even at higher pressure ranges.

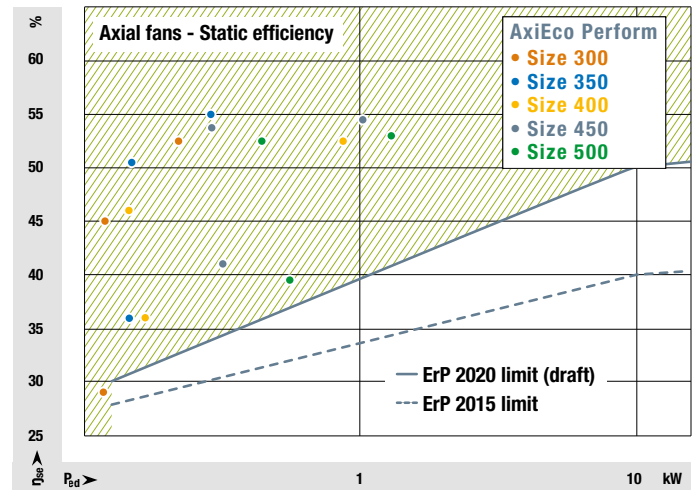
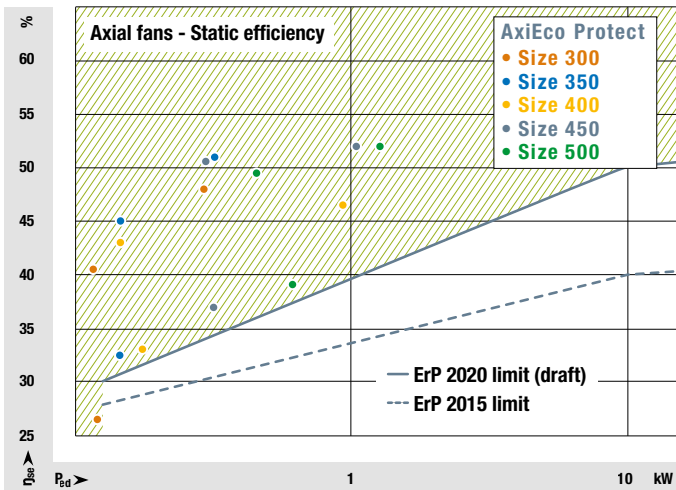

Why is it beneficial to me that the AxiEco series conforms to the ErP?

In the next stage of the ErP Directive (Energy-related products directive), the EU is stipulating mandatory minimum efficiency levels for fans. A device will only be able to bear the CE label if it fulfills the required standard values. With the AxiEco series, manufacturers are on the safe side and are ideally equipped for the future. The AxiEco series fully complies with the new ErP requirements.



What are the advantages of using EC motor technology?

The new AxiEco series meets the requirements of the next stage of the ErP regardless of the motor technology used, but EC technology offers additional benefits, for example:

- better efficiency than AC motors
- lower energy consumption and, therefore, less waste heat
- demand-based control via a 0 to 10 V signal
- some motor variants can also be controlled via MODBUS-RTU
- high efficiency and low energy consumption in partial-load operation
- high EC motor speeds permit much higher air performance

If you have any further questions, you can contact us at any time. Please contact: [+49 7938 81 0](tel:+497938810) or info1@de.ebmpapst.com

The air performance curve of the AxiEco series is much steeper than that of the HyBlade, and it offers all that at a high efficiency. (Example, size 350, 4-pole, AC)

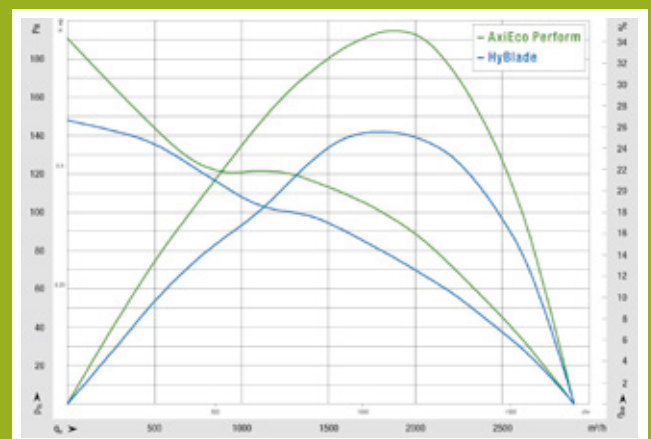
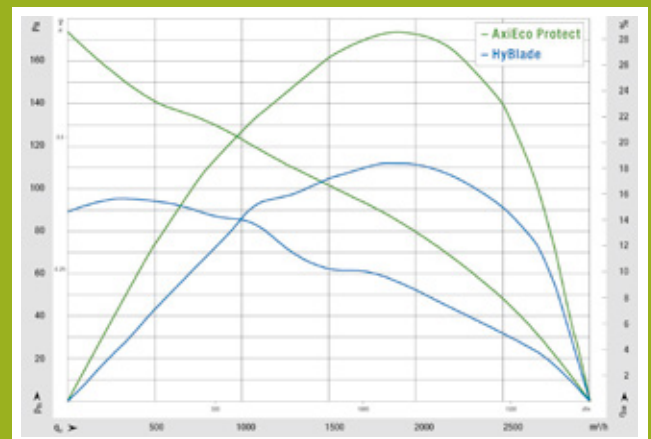

Top performance: *the AxiEco Protect.*

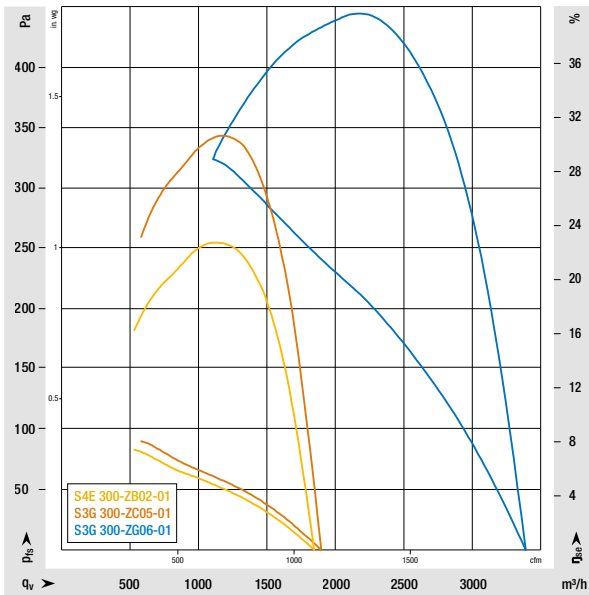

Characteristic curve field for size 300.

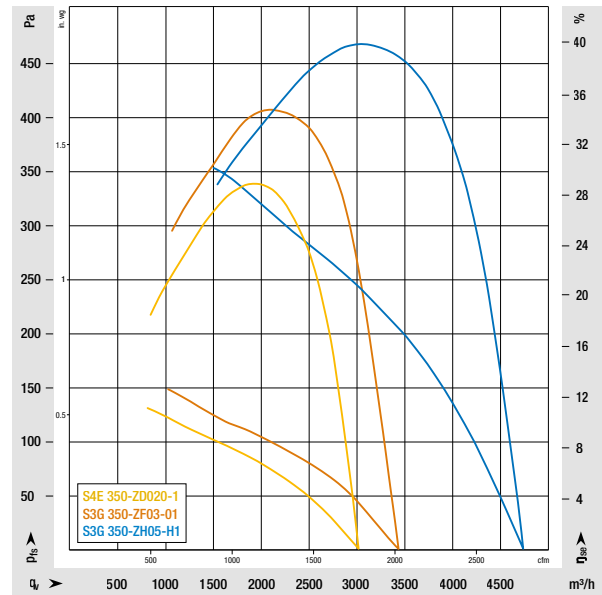

Characteristic curve field for size 350.

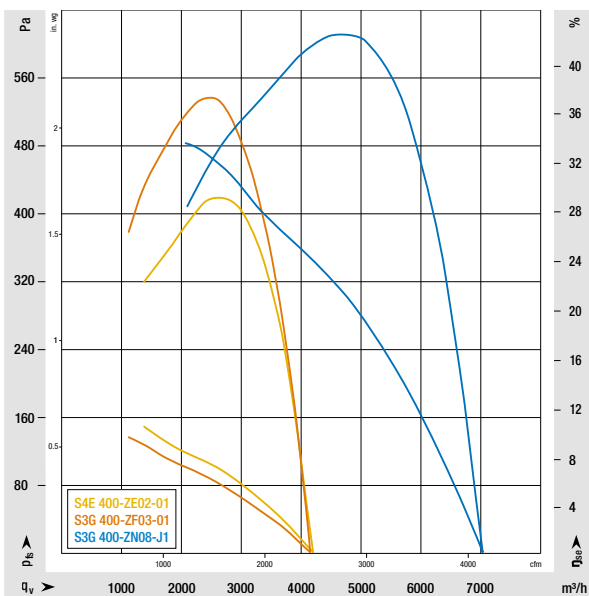

Characteristic curve field for size 400.

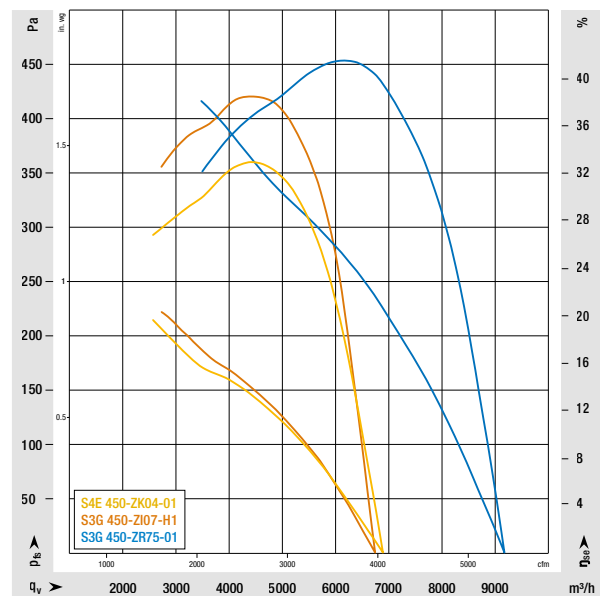

Characteristic curve field for size 450.

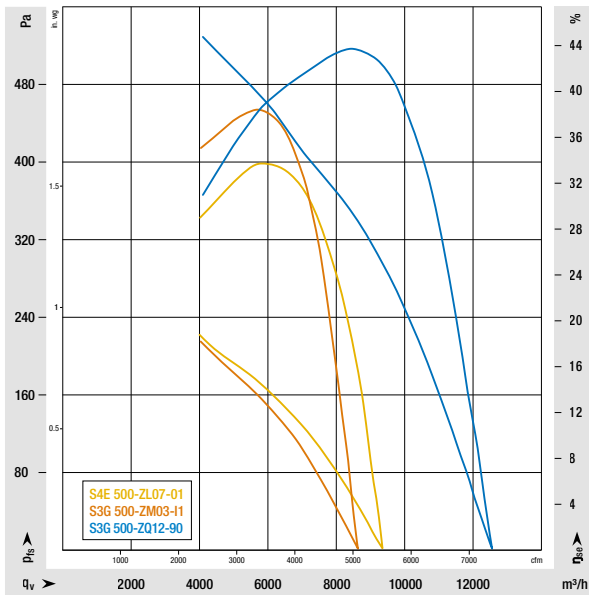

Characteristic curve field for size 500.

Nominal data			Nominal voltage range	Frequency	Speed ⁽¹⁾	Max. power consumption ⁽¹⁾	Max. input current ⁽¹⁾	Permiss. ambient temp. ⁽²⁾
Size	Item number	Motor	VAC	Hz	rpm	W	A	°C
300	S4E 300-ZB02-01	AC	1-230	50/60	1,225/1,200	75/100	0.33/0.44	-25 to +60/55
	S3G 300-ZC05-01	EC	1-200-240	50/60	1,270	65	0.60	-25 to +60
	S3G 300-ZG06-01	EC	1-200-277	50/60	2,400	345	1.52	-25 to +60
350	S4E 350-ZD02-01	AC	1-230	50	1,325	160	0.70	-25 to +60
	S3G 350-ZF03-01	EC	1-200-240	50/60	1,434	170	1.50	-25 to +60
	S3G 350-ZH05-H1	EC	1-200-277	50/60	2,200	500	2.30	-25 to +60
400	S4E 400-ZE02-01	AC	1-230	50	1,300	260	1.20	-25 to +60
	S3G 400-ZF03-01	EC	1-200-240	50/60	1,210	170	1.30	-25 to +60
	S3G 400-ZN08-J1	EC	3-380-480	50/60	2,300	1,010	1.60	-25 to +60
450	S4E 450-ZK04-01	AC	1-230	50/60	1,380/1,530	550/800	2.6/3.5	-25 to +60
	S3G 450-ZI07-H1	EC	1-200-277	50/60	1,390	500	2.20	-25 to +60
	S3G 450-ZR75-01	EC	3-380-480	50/60	1,910	1,200	1.90	-25 to +60
500	S4E 500-ZL07-01	AC	1-230	50	1,300	870	3.90	-25 to +60
	S3G 500-ZM03-I1	EC	1-200-277	50/60	1,270	650	2.90	-25 to +60
	S3G 500-ZQ12-90	EC	3-380-480	50/60	1,870	1,950	3.00	-25 to +60

Subject to technical changes.

⁽¹⁾ Nominal data at operating point with maximum load and 230 VAC or 480 VAC.

⁽²⁾ Variants up to -40°C for deep freeze applications available on request.

Values are measured with a guard grill.

In good shape: *the AxiEco Protect.*

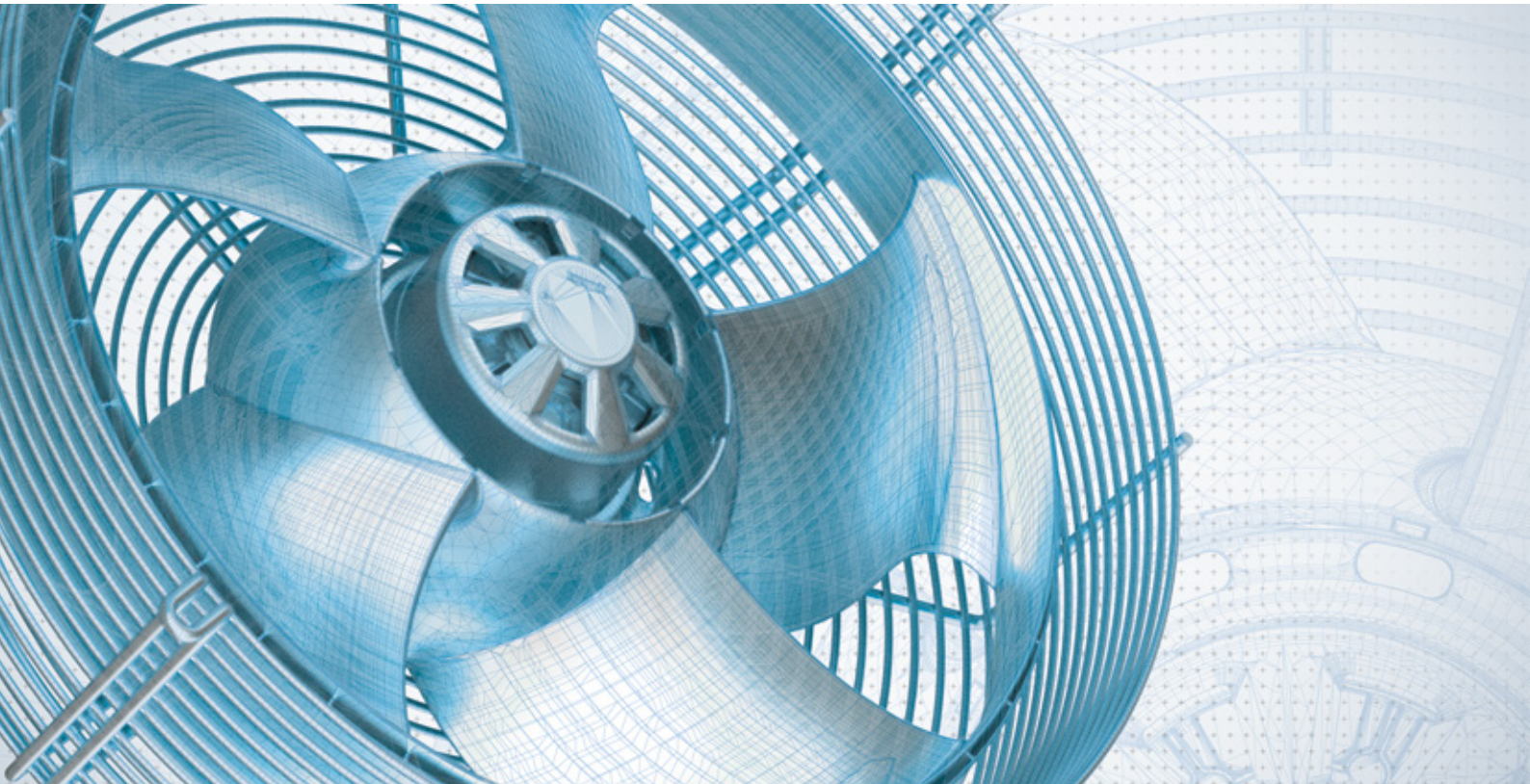
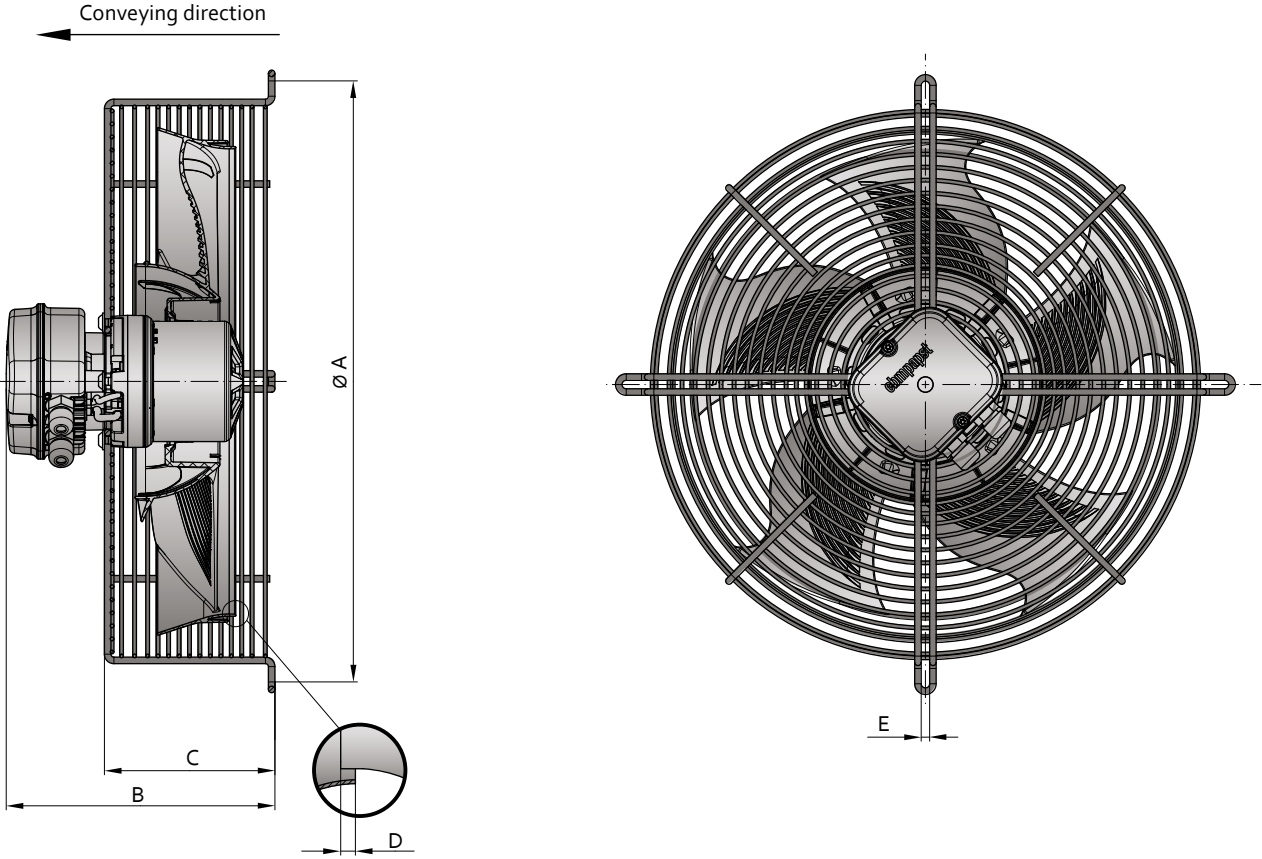

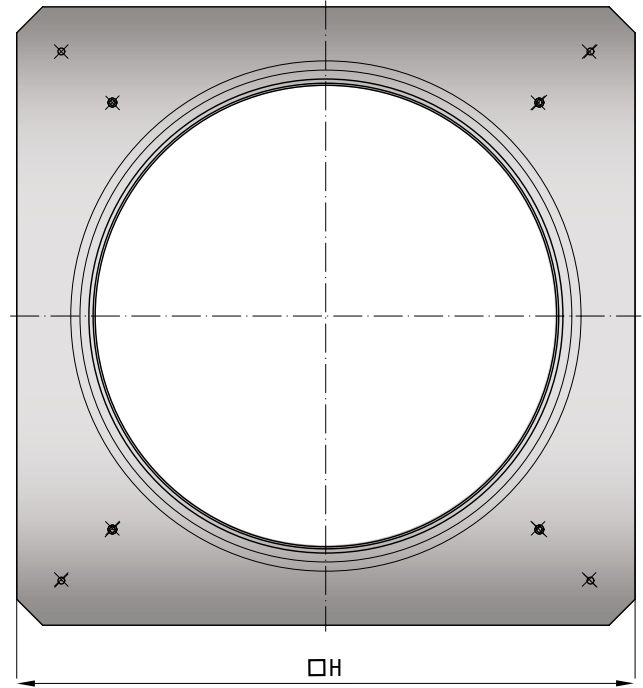
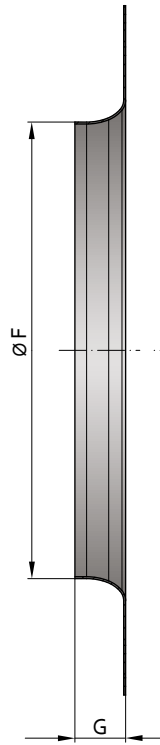

Dimensions

Size	Item number	Motor	Item number inlet ring	A	B	C	D	E	F	G	H
300	S4E 300-ZB02-01	AC		412	181	115					
	S3G 300-ZC05-01	EC	30100-2-4013	412	181	115	6	7	305.5	34	430
	S3G 300-ZG06-01	EC		412	210	122					
350	S4E 350-ZD02-01	AC		460	201	131					
	S3G 350-ZF03-01	EC	35100-2-4013	460	205	131	7.5	7	351	39	480
	S3G 350-ZH05-H1	EC		460	212	125					
400	S4E 400-ZE02-01	AC		513	221	149					
	S3G 400-ZF03-01	EC	40100-2-4013	513	225	149	12	7	394.5	42	530
	S3G 400-ZN08-J1	EC		513	261	156					
450	S4E 450-ZK04-01	AC		581	230	171					
	S3G 450-ZI07-H1	EC	45100-2-4013	581	259	175	12	7	448	48.8	595
	S3G 450-ZR75-01	EC		581	275	181					
500	S4E 500-ZL07-01	AC		649	254	196					
	S3G 500-ZM03-I1	EC	50100-2-4013	649	301	200	14	7	502	57	656
	S3G 500-ZQ12-90	EC		649	274	219					

Subject to technical changes. All dimensions in mm. Data sheets available on request.

Gathers performance: *the AxiEco Perform.*

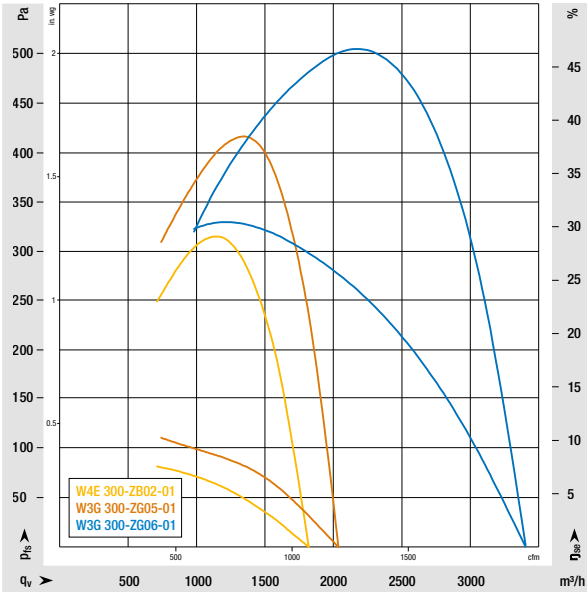

Characteristic curve field for size 300.

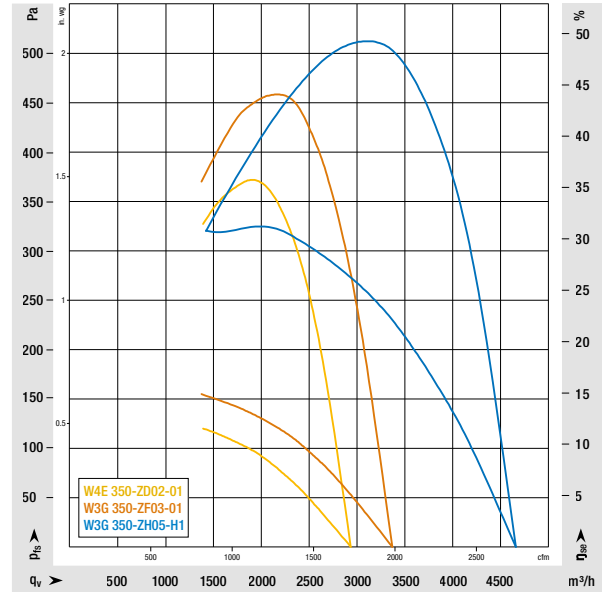

Characteristic curve field for size 350.

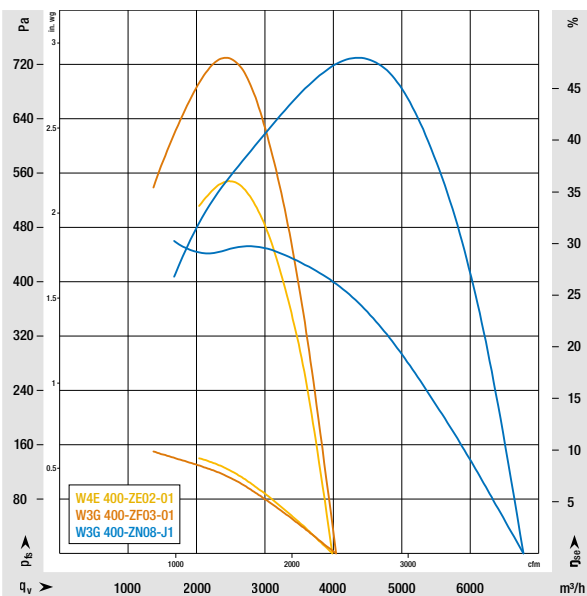

Characteristic curve field for size 400.

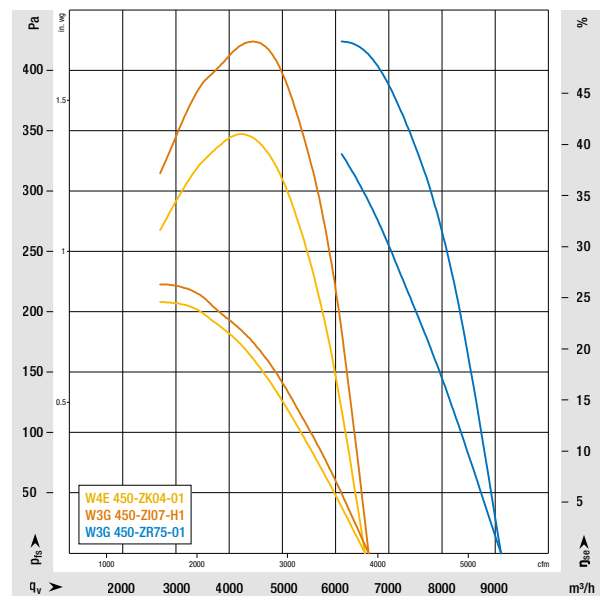

Characteristic curve field for size 450.

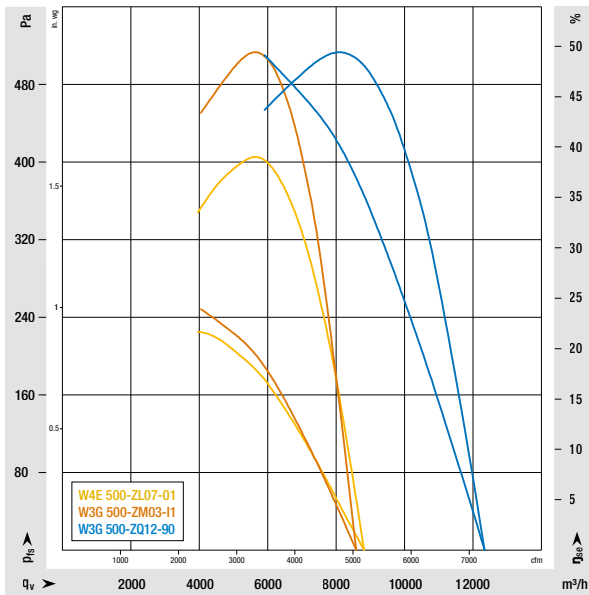

Characteristic curve field for size 500.

Nominal data			Nominal voltage range	Frequency	Speed ⁽¹⁾	Max. power consumption ⁽¹⁾	Permiss. ambient temp. ⁽²⁾
Size	Item number	Motor	VAC	Hz	rpm	W	°C
300	W4E 300-ZB02-01	AC	1-230	50	1,250	70	-25 to +60
	W3G 300-ZC05-01	EC	1-200-240	50/60	1,490	85	-25 to +60
	W3G 300-ZG06-01	EC	1-200-277	50/60	2,520	340	-25 to +60
350	W4E 350-ZD02-01	AC	1-230	50	1,350	150	-25 to +60
	W3G 350-ZF03-01	EC	1-200-240	50/60	1,540	170	-25 to +60
	W3G 350-ZH05-H1	EC	1-200-277	50/60	2,200	460	-25 to +60
400	W4E 400-ZE02-01	AC	1-230	50	1,340	235	-25 to +60
	W3G 400-ZF03-01	EC	1-200-240	50/60	1,400	160	-25 to +60
	W3G 400-ZN08-J1	EC	3-380-480	50/60	2,350	950	-25 to +60
450	W4E 450-ZK04-01	AC	1-230	50	1,400	505	-25 to +60
	W3G 450-ZI07-H1	EC	1-200-277	50/60	1,440	460	-25 to +60
	W3G 450-ZR75-01	EC	3-380-480	50/60	1,980	1,180	-25 to +60
500	W4E 500-ZL07-01	AC	1-230	50	1,300	760	-25 to +60
	W3G 500-ZM03-I1	EC	1-200-277	50/60	1,350	650	-25 to +60
	W3G 500-ZQ12-90	EC	3-380-480	50/60	1,950	1,930	-25 to +60

Subject to technical changes.

⁽¹⁾ Nominal data at operating point with maximum load and 230 VAC or 480 VAC.

⁽²⁾ Variants up to -40°C for deep freeze applications available on request.

Values are measured with a guard grill.

In the best shape: *the AxiEco Perform.*

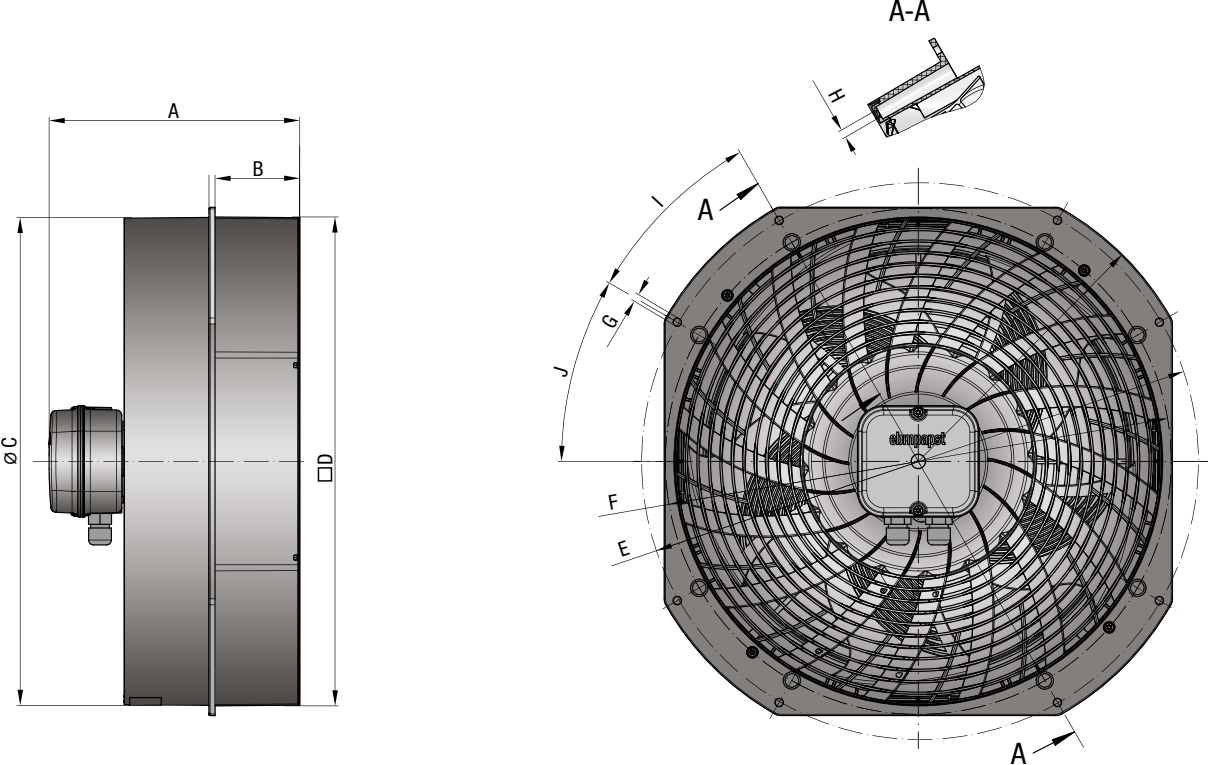

Dimensions

Size	Item number	Motor	A	B	C	D	E	F	G	H	I	J
300	W4E 300-ZB02-01	AC	181									
	W3G 300-ZC05-01	EC	181	60	355	355	412	370	7	7	30	30
	W3G 300-ZG06-01	EC	211									
350	W4E 350-ZD02-01	AC	203									
	W3G 350-ZF03-01	EC	207	70	403	404	460	418	7	7	30	30
	W3G 350-ZH05-H1	EC	213									
400	W4E 400-ZE02-01	AC	223									
	W3G 400-ZF03-01	EC	227	78	459	460	513	473	7	7	30	30
	W3G 400-ZN08-J1	EC	263									
450	W4E 450-ZK04-01	AC	233									
	W3G 450-ZI07-H1	EC	261	84	522	523	581	539	7	7	30	30
	W3G 450-ZR75-01	EC	276									
500	W4E 500-ZL07-01	AC	256									
	W3G 500-ZM03-I1	EC	303	88	582	584	649	602	7	7	30	30
	W3G 500-ZQ12-90	EC	277									

Subject to technical changes. All dimensions in mm. Data sheets available on request.

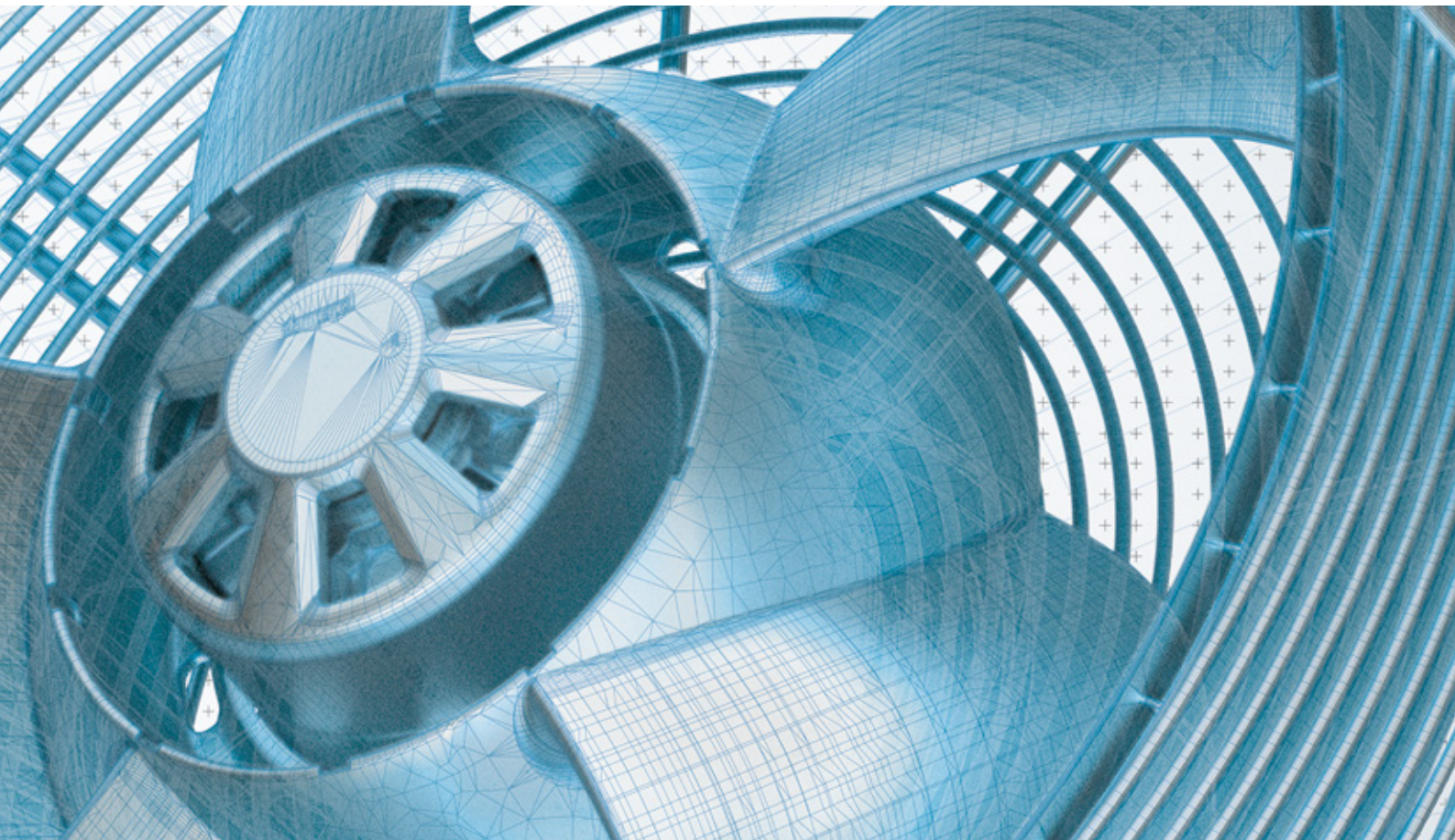

www.ebmpapst.com

ebmpapst

the engineer's choice

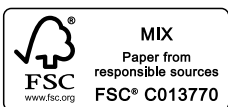

ebm-papst
Mulfingen GmbH & Co. KG

Bachmühle 2
74673 Mulfingen
Germany
Phone +49 7938 81-0
Fax +49 7938 81-110
info1@de.ebmpapst.com